

**cats**

**Panoramica prodotti**



**Products overview**



**Produktübersicht**



**Gamme de produits**



**Gama de productos**



**Gama de produtos**



**H  
A  
N  
D  
L  
I  
N  
G**

**Distributori Handling**  
**Distributors of Handling products**  
**Vertriebspartner Handling**  
**Distributeurs Handling**  
**Distribuidores Handling**  
**Distribuidores Handling**

06/09/2013

**GIMATIC**  
Group

**GIMATIC**  
Group

**CONSOciate ITALIANE**

*Piemonte, Liguria, Valle D'Aosta,  
Como, Lecco, Milano, Monza e Brianza,  
Pavia, Varese, Lodi, Verbania*  
**GIMATRADE S.r.l.**

Via Borgomanero, 1  
28010 Veruno (NO)  
Tel. +39 0322 830624  
Fax +39 0322 830624  
info@gimatrade.it  
www.gimatrade.it

*Bergamo, Brescia, Cremona, Mantova,  
Sondrio*

**GIMATRADE BRESCIA S.r.l.**

Via Chiusure, 5/b  
25127 Brescia (BS)  
Tel. +39 030 320212  
Fax +39 030 2415436  
info@gimatradebrescia.it  
www.gimatradebrescia.it

*Belluno, Treviso Nord, Pordenone,  
Venezia (Est Piave), Udine, Trieste e  
Gorizia*

**GIMATRADE TREVISO S.r.l.**

Via Giovanni Verga, 21  
33082 Corva di Azzano (PN)  
Tel. +39 0434 646156  
Fax +39 0434 646156  
info@gimatradetreviso.it  
www.gimatradetreviso.it

*Emilia Romagna*

**GIMATRADE EMILIA S.r.l.**

Via Medesano, 19  
43015 Noceto (PR)  
Tel. +39 0521 155 21 98  
Fax +39 0521 185 71 47  
info@gimatrademilia.it  
www.gimatrademilia.it

**FOREIGN SUBSIDIARIES**

**AUSLÄNDISCHE TOCHTERFIRMEN**

**ASSOCIES ETRANGERS**  
**FILIALES EXTRANJERAS**  
**FILIAIS ESTRANGEIRAS**

*Germany/Deutschland/Allemagne/  
Alemania/Alemanha*

**GIMATIC VERTRIEB GmbH**

Brunnenstr. 51  
D 72411 Bodelshausen  
Ph. +49 7471 96015 - 0  
Fax +49 7471 96015 - 19  
zentrale@gimaticvertrieb.de  
www.gimaticvertrieb.de

*Spain/Spainien/Espagne/España/  
Espanha*

**GIMATIC SPAIN s.l.**

C/Corín Tellado nº8 - 1ª  
33204 Gijón - Asturias - ESPAÑA  
Ph. +34 984 493 897  
Fax +34 984 493 897  
jrodriguez@gimaticspain.es  
www.gimaticspain.com

*Turkey/Türkei/Turquie/Turquia/Turquia*

**GIMATIC OTOMASYON TICARET  
LTD. STI.**

Perpa Tic. Merk. A Blok Kat:11  
No:1478  
34160 Okmeydani, Istanbul  
Ph. +90 212 210 83 91  
Fax +90 212 210 83 98  
gimatic@gimatic.com.tr

*Czech Republic/Tschechische  
Republik/République Tchèque/  
República Checa/República Checa,  
Slovakia/Slowakei/Slovaquia/  
Eslovaquia/Eslováquia*

**GIMATIC CZECH REPUBLIC, s.r.o.**

Pod Hájem 290  
250 73, Přezletice  
Ph. +420 608 954 500  
Fax +420 222 364 605  
info@gimatic.cz  
www.gimatic.cz

*Central and Latin America/Zentral-  
und Südamerika/Amérique centrale et  
latine/América Central y Sudamérica/  
América Central e Latina*

**GIMATIC AUTOMAÇÃO Ltda**

Rua Campos Salles, 190  
09551-310 Bairro Barcelona  
São Caetano do Sul  
São Paulo - BRASIL  
Ph. +55 11 4318 2550  
Fax +55 11 4318 2551  
gimatic@gimatic.com.br  
www.gimatic.com.br

**ITALIA**

*Bolzano, Trento, Verona*  
**CORA Elettroautomazioni S.r.l.**

V.le del Lavoro, 3  
38068 Rovereto (TN)  
Tel. +39 0464 420456  
Fax +39 0464 436673  
commerciale@elcora.com  
www.elcora.com

*Padova, Rovigo, Treviso Sud, Venezia  
(Ovest Piave), Vicenza*

**BRS AUTOMAZIONI S.r.l.**

Via A. Moro, 22/24  
45020 Villanova del Ghebbo (RO)  
Tel. +39 0425 669701  
Fax +39 0425 650505  
info@brsautomazioni.it

*Lazio, Campania, Puglia*

**FITAVA TRADING S.r.l.**

Via Napoli, 164/168  
84014 Nocera Inferiore (SA)  
Tel. +39 081 517 03 56  
Fax +39 081 517 03 60  
info@fitavatrading.com  
www.fitavatrading.com

*Marche, Abruzzo, Molise*

**BRAMMER ITALIA S.r.l.**

(Contattare la Gimatic SpA)

*Toscana e Umbria*

**TECHNO TEAM S.r.l.**

Via Baldanzese, 241  
50041 Calenzano (FI)  
Tel. +39 055 882 51 57  
Fax +39 055 887 78 36  
info@technoteamsrl.it  
www.technoteamsrl.it

**EUROPE**

*Austria/Österreich/Autriche/Austria/  
Áustria*

**BRUTECS GmbH**

Groß-Dönbach Straße, 12  
A-4073 Wilhering  
Ph. +43 664 380 6747  
Fax +43 7221 87093  
office@bruteecs.com  
www.bruteecs.com

*Belgium/Belgien/Belgique/Bélgica/  
Bélgica, Luxembourg/Luxemburg/  
Luxembourg/Luxemburgo/Luxemburgo*

**LDA NV/SA**

53 Hoge Buizen  
1980 Epegem - BELGIO  
Ph. +32 226 613 13  
Fax +32 226 247 14  
lda@lda.be  
www.lda.be

*Bulgaria/Bulgarien/Bulgarie/Bulgaria/  
Bulgária*

**MASTER Ltd**

26 Tsar Asen Str.  
7000 Ruse - BULGARIA  
Ph. +35 982 836 530  
Fax +35 982 826 530  
ruse@master-bg.com  
www.master-bg.com

*Denmark/Dänemark/Danemark/  
Dinamarca/Dinamarca, Iceland/  
Island/Islande/Islandia/Islandia*

**BONDY-LMT A/S**

Hassellunden 14  
DK-2765 Smorum DENMARK  
Ph. +45 701 514 14  
Fax +45 446 414 16  
mat@bondylmt.dk  
www.bondy.dk

*Estonia/Estland/Estonie/Estonia/  
Estónia, Lithuania/Litauen/Lituanie/  
Lituania/Lituânia, Latvia/Lettland/  
Lettonie/Letonia/Letônia, Finland/  
Finnland/Finlande/Finlandia/Finlândia*

**OY SCALAR Ltd**

Viertolantie 12  
11120 Riihimäki - FINLAND  
Ph. +35 810 387 29 55  
Fax +35 810 387 29 50  
info@scalar.fi  
www.scalar.fi

*France/Frankreich/France/Francia/  
França*  
**APORE**  
Z.I. De Sure 01390  
Saint Andre de Corcy - FRANCE  
Ph. +33 472 264477  
Fax +33 472 264064  
cwagnon@apore.fr  
www.apore.fr

*Greece/Griechenland/Grèce/Grecia/  
Grécia*  
**TECNOPNEUMATIC A.E.**  
97, Iera Odos Str.  
11855 Athens – GREECE  
Ph. +30 210 346 70 00  
Fax +30 210 347 99 30  
avieris@tecnopneumatic.gr  
www.tecnopneumatic.gr

*Hungary/Ungarn/Hongrie/Hungria/  
Hungria*  
**TECH-CON HUNGÁRIA KFT**  
1133 Budapest Véső u. 9-11.  
HUNGARY  
(bejárat Süllo u. 8.)  
Ph. +36 141 241 61  
Fax +36 141 241 71  
tech-con@tech-con.hu  
www.tech-con.hu

*Netherlands/Holland/Pays-Bas/Paises  
Bajos/Holanda*  
**GRIPPING & HANDLING  
SOLUTIONS**  
Amer 53  
5711 KJ Someren  
The Netherlands  
Ph. +31 654 962 059  
Fax +31 493 470 176  
info@g-solutions.com

*Polonia/Polen/Pologne/Polonia/  
Polónia*  
**DZV DOROTA ZDUNOWSKA**  
Plac Gornoslaski, 7  
81509 Gdynia POLAND  
Ph. +48 696 437 741  
Fax +48 587 421 710  
biuro@dzv.com.pl  
www.dzv.com.pl

*Portugal/Portugal/Portugal/Portugal/  
Portugal*  
**TECNOTRONICA Lda.**  
Zona Industrial da Murteira,  
Lote n.22  
2135 Samora Correia  
PORTUGAL  
Ph. +351 263 659 340  
Fax +351 263 659 349  
tecnotronica@mail.telepac.pt  
www.tmac.pt

*United Kingdom/Großbritannien/  
Grande-Bretagne/Reino Unido/Reino  
Unido*  
**PRECISION MOTION (COFIL) Ltd**  
PO BOX 2034, Preston  
PR5 9AD Lancashire  
Ph. +44 177 233 96 33  
Fax +44 177 233 63 62  
stuart@precisionmotion.co.uk  
www.precisionmotion.co.uk

*Serbia/Serbien/Serbie/Serbia/Sérbia  
Slovenia/Slowenien/Slovenie/  
Eslovenia/Eslovénia*  
*Croatia/Kroatien/Croatie/Croacia/  
Croácia*  
**KOVIMEX**  
Podskranik 60  
1380 Cerknica – SLOVENIA  
Ph. +386 (170) 96 430  
Fax +386 (402) 18 211  
kovimex@kovimex.si  
www.kovimex.si

*Switzerland/Schweiz/Suisse/Suiza/  
Suíça*  
**CREDIMEX AG**  
Untere Gründlistrasse 7  
CH-6055 Alpnach  
SWITZERLAND  
Ph. +41 41 666 29 49  
Fax +41 41 666 29 50  
credimex@credimex.ch  
www.credimex.ch

*Sweden/Schweden/Suède/Suecia/  
Suécia*  
**AIRTEC PNEUM. SW.**  
Gerfast Vag, 6 - Box 120  
28322 Osby - SWEDEN  
Ph. +46 (0)479 12600  
Fax +46 (0)479 12719  
mail@airtec.se  
www.airtec.se

## ASIA

*China/China/Chine/China/China*  
**SHANGHAI EURO POWER  
TRANSMISSION & CONTROL LTD.**  
4 floor, N21, 15 Lane  
Gudan Rd, Pudong District  
201315 Shanghai - CHINA  
Ph. +86 215 102 84 51  
Fax +86 215 102 88 72  
ptc@europtc.com  
www.europtc.com

*China (Guangdong Province)/China  
(Guangdong-Provinz)/Chine (Province  
de Guangdong)/China (provincia de  
Guangdong)/China (Provincia de  
Guangdong)*  
*Hong Kong/Hongkong/Hong Kong/  
Hong Kong/Hong Kong*  
*Macau/Macao/Macao/Macao/Macau*  
**BEAM REACH TECHNOLOGIES  
Co. Ltd.**  
Unit 14B, 11/F, Block 1,  
Nan Fung Industrial City,  
No.18 Tin Hau Road, N.T.,  
Hong Kong  
Ph. +852 24120032  
Fax +852 24120205  
info@brt.com.hk  
www.brt.com.hk

*India/Indien/Inde/India/Índia*  
**MPOWER**  
No: 210, Anna Street,  
Dever Nagar, Padi,  
Chennai - 600 050  
Ph. +9144 - 26542728  
Mobile +91 98406 01278  
sales.mpower@gmail.com

*Iran/Iran/Iran/Irán/Irão*  
**B.A.F.F. CO**  
10th Flat, No 29, Ezatipour Alley,  
Hakimhighway  
Teheran - IRAN  
Ph. (+98 21) 44004100  
Ph. (+98 21) 44004200  
Fax (+98 21) 44004300  
info@baffco.com  
www.baffco.com

*Israele/Israel/Israël/Israel/Israel*  
**R.E.P. Automation Ltd**  
2, HaAmelim St.  
P.O.B.10115  
Haifa Bay 26110  
Ph. +97 248 403 012  
Fax +97 248 403 013  
rep@repac.co.il  
www.repac.co.il

*Malesia/Malesien/Malaisie/Malasia/  
Malásia*  
*Thailand/Thailand/Thaïlande/  
Tailandia/Tailândia*  
**FUTURE STATE (Asia) Co. Ltd.**  
86/1 Soi Thianthalay, 22  
Bangkhunthian  
Thakham, Bangkhunthian  
10150 Bangkok Thailand  
Ph. +66 25 30 04 05  
Fax +66 25 30 04 06  
nianinbkk@hotmail.com  
www.futurestateasia.com

*Russia/Russland/Russie/Rusia/Rusia*  
**IBC SYSTEMS**  
Kuskovskaya str.20A, off.611A  
111141 Moscow - RUSSIA  
Ph. +74 957 270 528  
Fax +74 957 270 529  
info@ibcplastic.ru  
www.ibcplastic.ru

*Syria/Syrien/Syrie/Siria/Síria*  
**ETTA SYSTEMS**  
P.O.BOX: 12850  
Al Hamra St. Sha'lan  
Build # 10- 3ed Floor  
Damascus - SYRIA  
Ph. +96 311 332 55 19  
Fax +96 311 334 26 39  
info@ettasystems.com  
www.ettasystems.com

## AMERICA

*U.S.A. - Mexico/Mexiko/Mexique/  
México/México*  
**GIMATIC USA**  
28300 Euclid Ave.  
44092 Wickliffe, Ohio - USA  
Ph. +1 216 535 4811  
Fax +1 216 535 4833  
sales@gimaticusa.com  
www.gimaticusa.com

*Canada/Kanada/Canada/Canadá/  
Canadá*  
**SEMPRESS CANADA INC**  
9-3250 Ridgeway Drive  
L5L-5Y6  
Mississauga - Ontario - CANADA  
Ph. 905.949.2324  
Fax 905.949.1944  
brentmccurdy@sempress.ca  
www.sempress.ca

**Pinze parallele a 2 griffe**  
**2-jaw parallel grippers**  
**2-Backen-Parallelgreifer**  
**Pinces parallèles à 2 mâchoires**  
**Pinzas paralelas de 2 mordazas**  
**Pinças paralelas de 2 mordentes**



Per applicazioni pesanti - Heavy duty  
 Für Hochleistungsanwendungen - Pour applications lourdes  
 Para aplicaciones pesadas - Elevada energía interna

MG	F [N]	s [mm]	m [g]
MG-0010	70	2x2.6	60
MG-0011	36	2x4.6	65
MG-0012	140	2x1.2	60
MG-0025	140	2x4.3	160
MG-0025-NC	(2)	2x4.3	(2) (1)
MG-0025-NO	(2)	2x4.3	(2) (1)
MG-0026	80	2x7.4	170
MG-0026-NC	(2)	2x7.4	(2) (1)
MG-0026-NO	(2)	2x7.4	(2) (1)
MG-0027	260	2x2	150
MG-0027-NC	(2)	2x2	(2) (1)
MG-0027-NO	(2)	2x2	(2) (1)
MG-0050	320	2x5.7	370
MG-0050-NC	(2)	2x5.7	(2) (1)
MG-0050-NO	(2)	2x5.7	(2) (1)
MG-0051	180	2x9.9	380
MG-0051-NC	(2)	2x9.9	(2) (1)
MG-0051-NO	(2)	2x9.9	(2) (1)
MG-0052	600	2x2.7	350
MG-0052-NC	(2)	2x2.7	(2) (1)
MG-0052-NO	(2)	2x2.7	(2) (1)
MG-0075	500	2x9.5	940
MG-0075-NC	(2)	2x9.5	(2) (1)
MG-0075-NO	(2)	2x9.5	(2) (1)
MG-0076	320	2x16.4	980
MG-0076-NC	(2)	2x16.4	(2) (1)
MG-0076-NO	(2)	2x16.4	(2) (1)
MG-0077	1080	2x4.5	900
MG-0077-NC	(2)	2x4.5	(2) (1)
MG-0077-NO	(2)	2x4.5	(2) (1)
MG-0100	900	2x11.8	1500
MG-0100-NC	(2)	2x11.8	(2) (1)
MG-0100-NO	(2)	2x11.8	(2) (1)
MG-0101	420	2x20.5	1600
MG-0101-NC	(2)	2x20.5	(2) (1)
MG-0101-NO	(2)	2x20.5	(2) (1)
MG-0102	1540	2x5.5	1400
MG-0102-NC	(2)	2x5.5	(2) (1)
MG-0102-NO	(2)	2x5.5	(2) (1)
MG-0103	2400	2x2.9	1400
MG-0103-NC	(2)	2x2.9	(2) (1)
MG-0103-NO	(2)	2x2.9	(2) (1)

(1)

Articolo disponibile a richiesta, non gestito a magazzino  
 Item available upon request, not in stock  
 Artikel auf Wunsch lieferbar, nicht am Lager  
 Article disponible sur demande, non géré par le magasin  
 Artículo disponible bajo pedido, no gestionado en el almacén  
 Artigo disponível mediante solicitação, ausente do armazém



Per applicazioni pesanti - Heavy duty  
 Für Hochleistungsanwendungen - Pour applications lourdes  
 Para aplicaciones pesadas - Elevada energía interna

GM	F [N]	s [mm]	m [g]
GM-0010	70	2x2.6	70
GM-0011	36	2x4.6	75
GM-0012	140	2x1.2	70
GM-0025	140	2x4.3	200
GM-0025-NC	(2)	2x4.3	(2) (1)
GM-0025-NO	(2)	2x4.3	(2) (1)
GM-0026	80	2x7.4	210
GM-0026-NC	(2)	2x7.4	(2) (1)
GM-0026-NO	(2)	2x7.4	(2) (1)
GM-0027	260	2x2	190
GM-0027-NC	(2)	2x2	(2) (1)
GM-0027-NO	(2)	2x2	(2) (1)
GM-0050	320	2x5.7	370
GM-0050-NC	(2)	2x5.7	(2) (1)
GM-0050-NO	(2)	2x5.7	(2) (1)
GM-0051	180	2x9.9	380
GM-0051-NC	(2)	2x9.9	(2) (1)
GM-0051-NO	(2)	2x9.9	(2) (1)
GM-0052	600	2x2.7	350
GM-0052-NC	(2)	2x2.7	(2) (1)
GM-0052-NO	(2)	2x2.7	(2) (1)
GM-0075	500	2x9.5	1050
GM-0075-NC	(2)	2x9.5	(2) (1)
GM-0075-NO	(2)	2x9.5	(2) (1)
GM-0076	320	2x16.4	1100
GM-0076-NC	(2)	2x16.4	(2) (1)
GM-0076-NO	(2)	2x16.4	(2) (1)
GM-0077	1080	2x4.5	1000
GM-0077-NC	(2)	2x4.5	(2) (1)
GM-0077-NO	(2)	2x4.5	(2) (1)
GM-0100	900	2x11.8	1600
GM-0100-NC	(2)	2x11.8	(2) (1)
GM-0100-NO	(2)	2x11.8	(2) (1)
GM-0101	420	2x20.5	1700
GM-0101-NC	(2)	2x20.5	(2) (1)
GM-0101-NO	(2)	2x20.5	(2) (1)
GM-0102	1540	2x5.5	1600
GM-0102-NC	(2)	2x5.5	(2) (1)
GM-0102-NO	(2)	2x5.5	(2) (1)
GM-0103	2400	2x2.9	1580
GM-0103-NC	(2)	2x2.9	(2) (1)
GM-0103-NO	(2)	2x2.9	(2) (1)

(2)

Consultare il fabbricante  
 Consult Factory  
 Fragen Sie den Hersteller  
 Consulter l'usine  
 Consulte con el fabricante  
 Consultar a fábrica

**Pinze parallele a 2 griffe**  
**2-jaw parallel grippers**  
**2-Backen-Parallelgreifer**  
**Pinces parallèles à 2 mâchoires**  
**Pinzas paralelas de 2 mordazas**  
**Pinças paralelas de 2 mordentes**



Hi-energy inside  
 Hohe Innenenergie - Énergie élevée à l'intérieur  
 Alta energia interior - Elevada energia interna

MGX	F [N]	s [mm]	m [g]
<b>MGX2005</b>	180	2x2.5	95
MGX2005-NC	(2)	2x2.5	96 (1)
MGX2005-NO	(2)	2x2.5	96 (1)
<b>MGX2508</b>	290	2x4	150
MGX2508-NC	(2)	2x4	153 (1)
MGX2508-NO	(2)	2x4	153 (1)
<b>MGX3210</b>	460	2x5	270
MGX3210-NC	(2)	2x5	276 (1)
MGX3210-NO	(2)	2x5	276 (1)
<b>MGX4015</b>	750	2x7.5	545
MGX4015-NC	(2)	2x7.5	560 (1)
MGX4015-NO	(2)	2x7.5	560 (1)
<b>MGX5020</b>	1300	2x10	900
MGX5020-NC	(2)	2x10	930 (1)
MGX5020-NO	(2)	2x10	930 (1)
<b>MGX6030</b>	1660	2x15	1525
MGX6030-NC	(2)	2x15	1590 (1)
MGX6030-NO	(2)	2x15	1590 (1)



*gimapick*

S	F [N]	s [mm]	m [g]
<b>S25</b>	200	2x5.3	400
S25-NC	(2)	2x5.3	(2) (1)
S25-NO	(2)	2x5.3	(2) (1)



IP67

SX	F [N]	s [mm]	m [g]
<b>SX2510</b>	390-500	2x5	260
<b>SX2520</b>	390-500	2x10	310
<b>SX4020</b>	1000-1300	2x10	750
SX4020-NC	(2)	2x10	(2) (1)
<b>SX4040</b>	1000-1300	2x20	900
<b>SX5030</b>	1600-2100	2x15	1300
SX5030-NC	(2)	2x15	(2) (1)
<b>SX5060</b>	1600-2100	2x30	1700
<b>SX6340</b>	2500-3400	2x20	2800
SX6340-NC	(2)	2x20	(2) (1)
<b>SX6380</b>	2500-3400	2x40	3500

(1)  
 Articolo disponibile a richiesta, non gestito a magazzino  
 Item available upon request, not in stock  
 Artikel auf Wunsch lieferbar, nicht am Lager  
 Article disponible sur demande, non géré par le magasin  
 Artículo disponible bajo pedido, no gestionado en el almacén  
 Artigo disponível mediante solicitação, ausente do armazém



Corsa lunga - Long stroke  
 Langer Hub - Course longue  
 Carrera larga - Curso longo

SH	F [N]	s [mm]	m [g]
<b>SH6360</b>	1600	2x30	2600
<b>SH63120</b>	1600	2x60	5200
SH63120NC	(2)	2x60	(2) (1)
<b>SH8080</b>	2500	2x40	5000
<b>SH80150</b>	2500	2x75	8880



Il miglior prezzo - The best price  
 Der beste preis - Le meilleur prix  
 El mejor precio - O melhor preço

SZ	F [N]	s [mm]	m [g]
<b>SZ12</b>	50	2x4	94
SZ12-NC	(2)	2x4	(2) (1)
<b>SZ16</b>	90	2x6	153
SZ16-NC	(2)	2x6	(2) (1)
<b>SZ25</b>	230	2x10	446
SZ25-NC	(2)	2x10	(2) (1)
<b>SZ32</b>	380	2x12.5	722
SZ32-NC	(2)	2x12.5	(2) (1)
<b>SZ40</b>	620	2x15	1135
SZ40-NC	(2)	2x15	(2) (1)



Corsa lunga - Long stroke  
 Langer Hub - Course longue  
 Carrera larga - Curso longo

PQ	F [N]	s [mm]	m [g]
<b>PQ1608</b>	120	2x4	63
<b>PQ2012</b>	180	2x6	110
<b>PQ2516</b>	300	2x8	200
<b>PQ3015</b>	400	2x7.5	330
<b>PQ3523</b>	560	2x11.5	610
<b>PQ4533</b>	920	2x16.5	1270
<b>PQ5047</b>	1340	2x23.5	2430
<b>PQ6063</b>	1860	2x31.5	4900

(2)  
 Consultare il fabbricante  
 Consult Factory  
 Fragen Sie den Hersteller  
 Consulter l'usine  
 Consulte con el fabricante  
 Consultar a fábrica

**Pinze parallele a 2 griffe**  
**2-jaw parallel grippers**  
**2-Backen-Parallelgreifer**  
**Pinces parallèles à 2 mâchoires**  
**Pinzas paralelas de 2 mordazas**  
**Pinças paralelas de 2 mordentes**



Corsa lunga - Long stroke  
 Langer Hub - Course longue  
 Carrera larga - Curso longo

PE	F [N]	s [mm]	m [g]
PE-1610	200	2x5	200
PE-1625	200	2x12.5	250
PE-1640	200	2x20	350
PE-1680	200	2x40	500
PE-16150	200	2x75	900
PE-16200	200	2x100	1200
PE-2520	460	2x10	700
PE-2520-NC	(2)	2x10	(2) (1)
PE-2540	460	2x20	980
PE-2540-NC	(2)	2x20	(2) (1)
PE-2560	460	2x30	1285
PE-25100	460	2x50	1235
PE-25200	460	2x100	2080
PE-4520	1400	2x10	1840
PE-4520-NC	(2)	2x10	(2) (1)
PE-4520-NO	(2)	2x10	(2) (1)
PE-4540	1400	2x20	2250
PE-4540-NC	(2)	2x20	(2) (1)
PE-4540-NO	(2)	2x20	(2) (1)
PE-4560	1400	2x30	2715
PE-4560-NC	(2)	2x30	(2) (1)
PE-4560-NO	(2)	2x30	(2) (1)
PE-4580	1400	2x40	3330
PE-4580-NC	(2)	2x40	(2) (1)
PE-4580-NO	(2)	2x40	(2) (1)
PE-45200	1800	2x100	3800



Per alte velocità - High speed  
 Für Hochgeschwindigkeitsanwendungen - Pour machine à haute vitesse  
 Para altas velocidades - Para alta velocidade

HS	F [N]	s [mm]	m [g]
HS-2012	110-120	2x5.8	144
HS-2518	166-180	2x8.8	270

(1)  
 Articolo disponibile a richiesta, non gestito a magazzino  
 Item available upon request, not in stock  
 Artikel auf Wunsch lieferbar, nicht am Lager  
 Article disponible sur demande, non géré par le magasin  
 Artículo disponible bajo pedido, no gestionado en el almacén  
 Artigo disponível mediante solicitação, ausente do armazém



Pinze universali - Universal grippers  
 Universalgreifer - Pinces universelles  
 Pinzas universales - Pinças universais

DH	F [N]	s [mm]	m [g]
DH1905	136-150	2x2.5	87
DH1905-NC	194-92	2x2.5	100
DH1905-NO	78-208	2x2.5	98
DH2208	180-200	2x4	148
DH2208-NC	256-124	2x4	188
DH2208-NO	104-276	2x4	184
DH2204	360-400	2x2	150
DH2204-NC	510-250	2x2	190
DH2204-NO	210-550	2x2	186
DH2712	260-290	2x6	255
DH2712-NC	368-182	2x6	325
DH2712-NO	150-400	2x6	315
DH2706	520-580	2x3	260
DH2706-NC	736-364	2x3	330
DH2706-NO	300-802	2x3	320
DH3516	440-500	2x8	460
DH3516-NC	616-318	2x8	550
DH3516-NO	264-684	2x8	540
DH3508	880-1000	2x4	470
DH3508-NC	1234-634	2x4	560
DH3508-NO	530-1366	2x4	550
DH4420	730-810	2x10	780
DH4420-NC	1000-534	2x10	990
DH4420-NO	452-1088	2x10	960
DH4410	1460-1620	2x5	800
DH4410-NC	2014-1066	2x5	1010
DH4410-NO	904-2176	2x5	980
DH5526	1110-1250	2x13	1350
DH5526-NC	1562-802	2x13	1750
DH5526-NO	664-1698	2x13	1700
DH5512	2400-2700	2x6	1370
DH5512-NC	3372-1732	2x6	1770
DH5512-NO	1436-3666	2x6	1720
DH6632	1640-1840	2x16	2630
DH6632-NC	2260-1222	2x16	3430
DH6632-NO	1018-2464	2x16	3300
DH6616	3280-3680	2x8	2670
DH6616-NC	4520-2444	2x8	3470
DH6616-NO	2036-4928	2x8	3340
DH8750	2840-3120	2x25	4990
DH8750-NC	3858-2106	2x25	6920
DH8750-NO	1826-4136	2x25	6750
DH8728	5000-5500	2x14	5050
DH8728-NC	6794-3708	2x14	6980
DH8728-NO	3216-7286	2x14	6810

(2)  
 Consultare il fabbricante  
 Consult Factory  
 Fragen Sie den Hersteller  
 Consulter l'usine  
 Consulte con el fabricante  
 Consultar a fábrica

**Pinze parallele a 2 griffe**  
**2-jaw parallel grippers**  
**2-Backen-Parallelgreifer**  
**Pinces parallèles à 2 mâchoires**  
**Pinzas paralelas de 2 mordazas**  
**Pinças paralelas de 2 mordentes**



Protette contro le polveri - Protected against powders  
 Gegen Staub geschützt - Protégées contre les poussières  
 Protegidas contra el polvo - Protegidas contra o pó

XP	F [N]	s [mm]	m [g]
<b>XP-20</b>	170-200	2x4	160
<b>XP-20-NC</b>	(2)	2x4	(2) (1)
<b>XP-20-NO</b>	(2)	2x4	(2) (1)
<b>XP-26</b>	220-240	2x6.6	300
<b>XP-26-NC</b>	(2)	2x6.6	(2) (1)
<b>XP-26-NO</b>	(2)	2x6.6	(2) (1)



Pinza ad aghi - Needle gripper  
 Nadelgreifer - Pinces à aiguilles  
 Pinzas de agujas - Pinças de agulhas

PT25	F [N]	s [mm]	m [g]
<b>PT25</b>	90	2x7	165



Ora con sensori regolabili - Now with adjustable sensors  
 Jetzt mit einstellbaren Sensoren - Maintenant avec capteurs réglables  
 Ahora con sensores regulables - Agora com sensores ajustáveis

SGP-S	F [N]	s [mm]	m [g]
<b>SGP-20S</b>	40-46	2x2	33
<b>SGP-25S</b>	94-104	2x3	43
<b>SGP-32S</b>	120-134	2x4	86
<b>SGP-40S</b>	146-160	2x6	170



Disegno compatto - Compact design  
 Kompakte Konstruktion - Dessin compact  
 Diseño compacto - Design compacto

JP	F [N]	s [mm]	m [g]
<b>JP-25</b>	240-270	2x4.75	240
<b>JP-32</b>	600-700	2x6	450
<b>JP-45</b>	930-1000	2x9.45	1050

(1)  
 Articolo disponibile a richiesta, non gestito a magazzino  
 Item available upon request, not in stock  
 Artikel auf Wunsch lieferbar, nicht am Lager  
 Article disponible sur demande, non géré par le magasin  
 Artículo disponible bajo pedido, no gestionado en el almacén  
 Artigo disponível mediante solicitação, ausente do armazém



Pinze universali - Universal grippers  
 Universalgreifer - Pinces universelles  
 Pinzas universales - Pinças universais

GS	F [N]	s [mm]	m [g]
<b>GS-10</b>	28-36	2x2.3	45
<b>GS-10-NC</b>	40-24	2x2.3	45 (1)
<b>GS-10-NO</b>	18-46	2x2.3	45 (1)
<b>GS-16</b>	86-100	2x3.4	98
<b>GS-16-NC</b>	116-70	2x3.4	99 (1)
<b>GS-16-NO</b>	60-126	2x3.4	99 (1)
<b>GS-20</b>	186-212	2x5.2	207
<b>GS-20-NC</b>	228-170	2x5.2	209 (1)
<b>GS-20-NO</b>	134-264	2x5.2	209 (1)
<b>GS-25</b>	254-282	2x7.2	365
<b>GS-25-NC</b>	(2)	2x7.2	(2) (1)
<b>GS-25-NO</b>	190-346	2x7.2	369 (1)
<b>GS-32</b>	430-500	2x11	645
<b>GS-32-NC</b>	(2)	2x11	(2) (1)
<b>GS-32-NO</b>	(2)	2x11	(2) (1)
<b>GS-40</b>	614-700	2x15	1155
<b>GS-40-NC</b>	(2)	2x15	(2) (1)
<b>GS-40-NO</b>	(2)	2x15	(2) (1)

(2)  
 Consultare il fabbricante  
 Consult Factory  
 Fragen Sie den Hersteller  
 Consulter l'usine  
 Consulte con el fabricante  
 Consultar a fábrica

**Pinze radiali a 2 griffe**  
**2-jaw radial-acting grippers**  
**2-Backen-Winkelgreifer**  
**Pinces radiale à 2 mâchoires**  
**Pinzas radiales de 2 mordazas**  
**Pinças radiais de 2 mordentes**



<b>XR</b>	C [Ncm]	s	m [g]
<b>XR-20</b>	300-320	2x92°	140
<b>XR-26</b>	600-640	2x92°	260



Per applicazioni pesanti - Heavy duty  
 Für Hochleistungsanwendungen - Pour applications lourdes  
 Para aplicaciones pesadas - Elevada energía interna

<b>PS</b>	C [Ncm]	s	m [g]
<b>PS-0030</b>	400	2x91°	750
<b>PS-0050</b>	1200	2x91°	1670



Coppia costante - Constant torque  
 Konstantes Drehmoment - Couple constant  
 Par constante - Binário constante

<b>PS-P</b>	C [Ncm]	s	m [g]
<b>PS-0016-P</b>	200	2x90°	320
<b>PS-0025-P</b>	560	2x90°	650
<b>PS-0045-P</b>	3600	2x90°	2700



<b>GX-S</b>	C [Ncm]	s	m [g]
<b>GX-10S</b>	52-70	2x90°	70
<b>GX-16S</b>	210-240	2x90°	140
<b>GX-20S</b>	420-460	2x90°	290
<b>GX-25S</b>	800-860	2x90°	510



**Pinze angolari a 2 griffe**  
**2-jaw angular-acting grippers**  
**2-Backen-Winkelgreifer**  
**Pinces angulaire à 2 mâchoires**  
**Pinzas angulares de 2 mordazas**  
**Pinças angulares de 2 mordentes**



Pinze universali - Universal grippers  
 Universalgreifer - Pinces universelles  
 Pinzas universales - Pinças universais

GW	C [Ncm]	s	m [g]
<b>GW-10</b>	16-22	2x20°	39
GW-10-NC	(2)	2x20°	(2) (1)
<b>GW-10-NO</b>	8-30	2x20°	39
<b>GW-16</b>	72-90	2x20°	88
GW-16-NC	36-66	2x20°	89
<b>GW-16-NO</b>	48-114	2x20°	89
<b>GW-20</b>	156-178	2x20°	180
GW-20-NC	(2)	2x20°	(2) (1)
<b>GW-20-NO</b>	104-230	2x20°	182
<b>GW-25</b>	320-356	2x20°	300
GW-25-NC	(2)	2x20°	(2) (1)
GW-25-NO	(2)	2x20°	(2) (1)



XA	C [Ncm]	s	m [g]
<b>XA-20</b>	92-100	2x30°	140
XA-20-NC	(2)	2x30°	(2) (1)
XA-20-NO	(2)	2x30°	(2) (1)
<b>XA-26</b>	158-170	2x32°	250
XA-26-NC	(2)	2x32°	(2) (1)
XA-26-NO	(2)	2x32°	(2) (1)



Corsa regolabile - Stroke adjustment  
 Einstellbarer - Course réglable  
 Carrera regulable - Curso ajustável

AA	C [Ncm]	s	m [g]
<b>AA-25-NO</b>	250-50	2x14°	105



Non autocentrante - Non-selfcentering  
 Nicht selbstzentrierend - Non autocentrante  
 No autocentrante - Não auto-centrante

PB	C [Ncm]	s	m [g]
<b>PB-0010</b>	180	2x11°	100
<b>PB-0020</b>	800	2x7°	350



A 2 o 3 griffe - 2 or 3 jaws  
 2- oder 3-Backen - À 2 ou 3 mâchoires  
 De 2 o 3 mordazas - A 2 ou 3 mordentes

PN	C [Ncm]	s	m [g]
<b>PN-010-2</b>	30	2x19°	32
<b>PN-010-3</b>	30	3x19°	36
<b>PN-016-2</b>	114	2x19°	105
<b>PN-016-3</b>	114	3x19°	115
<b>PN-025-2</b>	498	2x19°	340
<b>PN-025-3</b>	498	3x19°	400
<b>PN-040-2</b>	1302	2x19°	910
<b>PN-040-3</b>	1302	3x19°	1040



TFA	C [Ncm]	s	m [g]
<b>TFA10-25</b>	34	2x12.5	12
<b>TFA14-25</b>	96	2x12.5	30
<b>TFA20-25</b>	430	2x12.5	95
<b>TFA20-25S</b>	430	2x12.5	120

(1)  
 Articolo disponibile a richiesta, non gestito a magazzino  
 Item available upon request, not in stock  
 Artikel auf Wunsch lieferbar, nicht am Lager  
 Article disponible sur demande, non géré par le magasin  
 Artículo disponible bajo pedido, no gestionado en el almacén  
 Artigo disponível mediante solicitação, ausente do armazém

(2)  
 Consultare il fabbricante  
 Consult Factory  
 Fragen Sie den Hersteller  
 Consulter l'usine  
 Consulte con el fabricante  
 Consultar a fábrica

**Pinze parallele a 3 griffe**  
**3-jaw parallel-acting grippers**  
**3-Backen-Parallelgreifer**  
**Pinces parallèles à 3 mâchoires**  
**Pinzas paralelas de 3 mordazas**  
**Pinças paralelas de 3 mordentes**



Pinze universali - Universal grippers  
 Universalgreifer - Pinces universelles  
 Pinzas universales - Pinças universais

TH	F [N]	s [mm]	m [g]
TH2725	261-285	3x2.5	117
TH2725-NC	345-201	3x2.5	140
TH2725-NO	177-369	3x2.5	139
TH3304	381-426	3x4	237
TH3304-NC	504-303	3x4	293
TH3304-NO	255-552	3x4	285
TH3302	750-855	3x2	240
TH3302-NC	1005-603	3x2	296
TH3302-NO	510-1098	3x2	288
TH4506	735-795	3x6	430
TH4506-NC	969-564	3x6	540
TH4506-NO	507-1026	3x6	530
TH4503	1470-1590	3x3	440
TH4503-NC	1932-1125	3x3	550
TH4503-NO	1011-2043	3x3	530
TH5408	1050-1140	3x8	760
TH5408-NC	1380-825	3x8	930
TH5408-NO	735-1470	3x8	920
TH5404	2130-2280	3x4	770
TH5404-NC	2757-1650	3x4	940
TH5404-NO	1470-2940	3x4	930
TH7610	2160-2280	3x10	1420
TH7610-NC	2793-1638	3x10	1870
TH7610-NO	1500-2931	3x10	1840
TH7605	4290-4500	3x5	1430
TH7605-NC	5550-3258	3x5	1880
TH7605-NO	2982-5826	3x5	1850
TH9613	3480-3630	3x13	2450
TH9613-NC	4452-2652	3x13	3230
TH9613-NO	2484-4620	3x13	3140
TH9606	7500-7860	3x6	2490
TH9606-NC	9639-5739	3x6	3270
TH9606-NO	5379-9999	3x6	3180
TH12516	5640-6150	3x16	4920
TH12516-NC	7041-4773	3x16	6640
TH12516-NO	4260-7554	3x16	6460
TH12508	11220-12210	3x8	4990
TH12508-NC	13965-9465	3x8	6710
TH12508-NO	8451-14979	3x8	6530

(1)

Articolo disponibile a richiesta, non gestito a magazzino  
 Item available upon request, not in stock  
 Artikel auf Wunsch lieferbar, nicht am Lager  
 Article disponible sur demande, non géré par le magasin  
 Artículo disponible bajo pedido, no gestionado en el almacén  
 Artigo disponível mediante solicitação, ausente do armazém



T	F [N]	s [mm]	m [g]
T30	315-345	3x3	325
T40	540-600	3x5	745
T63	1320-1440	3x9	1680



Protette contro le polveri - Protected against powders  
 Gegen Staub geschützt - Protégées contre les poussières  
 Protegidas contra el polvo - Protegidas contra o pó

XT	F [N]	s [mm]	m [g]
XT-20	171-201	3x3.6	210
XT-20-NC	(2)	3x3.6	(2) (1)
XT-20-NO	(2)	3x3.6	(2) (1)
XT-26	219-240	3x6.6	350
XT-26-NC	(2)	3x6.6	(2) (1)
XT-26-NO	(2)	3x6.6	(2) (1)



SXT	F [N]	s [mm]	m [g]
SXT2505	585-750	3x5	430
SXT2505-NC	(2)	3x5	(2) (1)
SXT4008	1500-1950	3x8	1100
SXT4008-NC	(2)	3x8	(2) (1)
SXT5012	2400-3150	3x12	2000
SXT5012-NC	(2)	3x12	(2) (1)
SXT6315	3600-4950	3x15	3800
SXT6315-NC	(2)	3x15	(2) (1)

(2)

Consultare il fabbricante  
 Consult Factory  
 Fragen Sie den Hersteller  
 Consulter l'usine  
 Consulte con el fabricante  
 Consultar a fábrica

Pinze ad espansione  
Air hands  
ID Innengreifer  
Préhenseurs intérieurs  
Pinzas de expansión  
Pegas interiores

MFD...CL MFD...HL

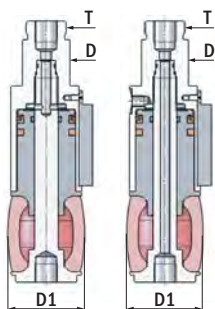

MFD	T	D [mm]	D1 [mm]	m [g]
MFD08S01CL	M12x1	Ø14	Ø8+Ø11	15
MFD08E02CL	M12x1	Ø14	Ø8+Ø11	15
MFD08S01HL	M12x1	Ø14	Ø8+Ø11	15
MFD08E02HL	M12x1	Ø14	Ø8+Ø11	15
MFD10S01CL	M12x1	Ø14	Ø10.5+Ø14	16
MFD10E02CL	M12x1	Ø14	Ø10.5+Ø14	16
MFD10S01HL	M12x1	Ø14	Ø10.5+Ø14	16
MFD10E02HL	M12x1	Ø14	Ø10.5+Ø14	16
MFD12S01CL	M12x1	Ø14	Ø13+Ø17	17
MFD12E02CL	M12x1	Ø14	Ø13+Ø17	17
MFD12S01HL	M12x1	Ø14	Ø13+Ø17	17
MFD12E02HL	M12x1	Ø14	Ø13+Ø17	17
MFD14S01CL	M12x1	Ø14	Ø15+Ø19.5	17
MFD14E02CL	M12x1	Ø14	Ø15+Ø19.5	17
MFD14S01HL	M12x1	Ø14	Ø15+Ø19.5	17
MFD14E02HL	M12x1	Ø14	Ø15+Ø19.5	17
MFD16S01CL	M12x1	Ø14	Ø17+Ø21	17
MFD16E02CL	M12x1	Ø14	Ø17+Ø21	17
MFD16S01HL	M12x1	Ø14	Ø17+Ø21	17
MFD16E02HL	M12x1	Ø14	Ø17+Ø21	17
MFD18S01CL	M12x1	Ø14	Ø19.5+Ø25	28
MFD18E02CL	M12x1	Ø14	Ø19.5+Ø25	28
MFD18S01HL	M12x1	Ø14	Ø19.5+Ø25	28
MFD18E02HL	M12x1	Ø14	Ø19.5+Ø25	28
MFD22S01CL	M12x1	Ø14	Ø24+Ø31.5	43
MFD22E02CL	M12x1	Ø14	Ø24+Ø31.5	43
MFD22S01HL	M12x1	Ø14	Ø24+Ø31.5	43
MFD22E02HL	M12x1	Ø14	Ø24+Ø31.5	43
MFD27S01CL	M17x1	Ø20	Ø28+Ø37	79
MFD27E02CL	M17x1	Ø20	Ø28+Ø37	79
MFD27S01HL	M17x1	Ø20	Ø28+Ø37	79
MFD27E02HL	M17x1	Ø20	Ø28+Ø37	79
MFD33S01CL	M17x1	Ø20	Ø34+Ø45	118
MFD33E02CL	M17x1	Ø20	Ø34+Ø45	118
MFD33S01HL	M17x1	Ø20	Ø34+Ø45	118
MFD33E02HL	M17x1	Ø20	Ø34+Ø45	118
MFD41S01CL	M27x1	Ø30	Ø42+Ø54	280
MFD41E02CL	M27x1	Ø30	Ø42+Ø54	280
MFD41S01HL	M27x1	Ø30	Ø42+Ø54	280
MFD41E02HL	M27x1	Ø30	Ø42+Ø54	280
MFD47S01CL	M27x1	Ø30	Ø48+Ø60	280
MFD47E02CL	M27x1	Ø30	Ø48+Ø60	280
MFD47S01HL	M27x1	Ø30	Ø48+Ø60	280
MFD47E02HL	M27x1	Ø30	Ø48+Ø60	280
MFD51S01CL	M27x1	Ø30	Ø54+Ø68	490
MFD51E02CL	M27x1	Ø30	Ø54+Ø68	490
MFD51S01HL	M27x1	Ø30	Ø54+Ø68	490
MFD51E02HL	M27x1	Ø30	Ø54+Ø68	490
MFD63S01CL	M27x1	Ø30	Ø66+Ø85	800
MFD63E02CL	M27x1	Ø30	Ø66+Ø85	800
MFD63S01HL	M27x1	Ø30	Ø66+Ø85	800
MFD63E02HL	M27x1	Ø30	Ø66+Ø85	800

MFU...CL MFU...HL

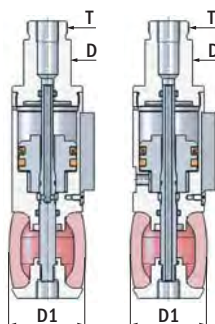

MFU	T	D [mm]	D1 [mm]	m [g]
MFU08S01CL	M12x1	Ø14	Ø8+Ø11	16
MFU08E02CL	M12x1	Ø14	Ø8+Ø11	16
MFU08S01HL	M12x1	Ø14	Ø8+Ø11	16
MFU08E02HL	M12x1	Ø14	Ø8+Ø11	16
MFU10S01CL	M12x1	Ø14	Ø10.5+Ø14	17
MFU10E02CL	M12x1	Ø14	Ø10.5+Ø14	17
MFU10S01HL	M12x1	Ø14	Ø10.5+Ø14	17
MFU10E02HL	M12x1	Ø14	Ø10.5+Ø14	17
MFU12S01CL	M12x1	Ø14	Ø13+Ø17	18
MFU12E02CL	M12x1	Ø14	Ø13+Ø17	18
MFU12S01HL	M12x1	Ø14	Ø13+Ø17	18
MFU12E02HL	M12x1	Ø14	Ø13+Ø17	18
MFU14S01CL	M12x1	Ø14	Ø15+Ø19.5	20
MFU14E02CL	M12x1	Ø14	Ø15+Ø19.5	20
MFU14S01HL	M12x1	Ø14	Ø15+Ø19.5	20
MFU14E02HL	M12x1	Ø14	Ø15+Ø19.5	20
MFU16S01CL	M12x1	Ø14	Ø17+Ø21	20
MFU16E02CL	M12x1	Ø14	Ø17+Ø21	20
MFU16S01HL	M12x1	Ø14	Ø17+Ø21	20
MFU16E02HL	M12x1	Ø14	Ø17+Ø21	20
MFU18S01CL	M12x1	Ø14	Ø19.5+Ø25	35
MFU18E02CL	M12x1	Ø14	Ø19.5+Ø25	35
MFU18S01HL	M12x1	Ø14	Ø19.5+Ø25	35
MFU18E02HL	M12x1	Ø14	Ø19.5+Ø25	35
MFU22S01CL	M12x1	Ø14	Ø24+Ø31.5	50
MFU22E02CL	M12x1	Ø14	Ø24+Ø31.5	50
MFU22S01HL	M12x1	Ø14	Ø24+Ø31.5	50
MFU22E02HL	M12x1	Ø14	Ø24+Ø31.5	50
MFU27S01CL	M17x1	Ø20	Ø28+Ø37	100
MFU27E02CL	M17x1	Ø20	Ø28+Ø37	100
MFU27S01HL	M17x1	Ø20	Ø28+Ø37	100
MFU27E02HL	M17x1	Ø20	Ø28+Ø37	100
MFU33S01CL	M17x1	Ø20	Ø34+Ø45	130
MFU33E02CL	M17x1	Ø20	Ø34+Ø45	130
MFU33S01HL	M17x1	Ø20	Ø34+Ø45	130
MFU33E02HL	M17x1	Ø20	Ø34+Ø45	130
MFU41S01CL	M27x1	Ø30	Ø42+Ø54	300
MFU41E02CL	M27x1	Ø30	Ø42+Ø54	300
MFU41S01HL	M27x1	Ø30	Ø42+Ø54	300
MFU41E02HL	M27x1	Ø30	Ø42+Ø54	300
MFU47S01CL	M27x1	Ø30	Ø48+Ø60	300
MFU47E02CL	M27x1	Ø30	Ø48+Ø60	300
MFU47S01HL	M27x1	Ø30	Ø48+Ø60	300
MFU47E02HL	M27x1	Ø30	Ø48+Ø60	300
MFU51S01CL	M27x1	Ø30	Ø54+Ø68	500
MFU51E02CL	M27x1	Ø30	Ø54+Ø68	500
MFU51S01HL	M27x1	Ø30	Ø54+Ø68	500
MFU51E02HL	M27x1	Ø30	Ø54+Ø68	500
MFU63S01CL	M27x1	Ø30	Ø66+Ø85	785
MFU63E02CL	M27x1	Ø30	Ø66+Ø85	785
MFU63S01HL	M27x1	Ø30	Ø66+Ø85	785
MFU63E02HL	M27x1	Ø30	Ø66+Ø85	785

Micro pinze ad espansione  
 ID expansion grippers  
 Mikro-Innengreifer  
 Micro doigt de préhension à expansion  
 Micropinzas de expansión  
 Micro pinça de preensão de expansão



IFU...RT	T	D1 [mm]	m [g]
IFU04S01RT	M10x1	Ø4.5÷Ø5.4	7
IFU04N03RT	M10x1	Ø4.5÷Ø5.4	7
IFU05S01RT	M10x1	Ø5.6÷Ø6.7	7
IFU05N03RT	M10x1	Ø5.6÷Ø6.7	7
IFU06S01RT	M10x1	Ø6.6÷Ø7.6	8
IFU06N03RT	M10x1	Ø6.6÷Ø7.6	8
IFU07S01RT	M10x1	Ø7.6÷Ø8.7	9
IFU07N03RT	M10x1	Ø7.6÷Ø8.7	9

Slitte  
 Slides  
 Schlitten  
 Tables de translation  
 Correderas  
 Corrediças



Per applicazioni pesanti  
 Heavy duty  
 Für Hochleistungsanwendungen  
 Pour applications lourdes  
 Para aplicaciones pesadas  
 Elevada energia interna

Z	F [N]	s [mm]	m [g]
Z-0825	37-50	25	230 (3)
Z-0825-D	37-50	25	270 (4)
Z-0825-DS	37-50	25	254 (5)
Z-0850	37-50	50	320 (3)
Z-0850-D	37-50	50	360 (4)
Z-0850-DS	37-50	50	344 (5)
Z-1650	170-200	50	620 (3)
Z-1650-D	170-200	50	730 (4)
Z-1650-DS	170-200	50	700 (5)
Z-16100	170-200	100	1010 (3)
Z-16100-D	170-200	100	1120 (4)
Z-16100-DS	170-200	100	1090 (5)
Z-16150	170-200	150	1340 (3)
Z-16150-D	170-200	150	1450 (4)
Z-16150-DS	170-200	150	1420 (5)
Z-2050-D	300-330	50	1300 (4)
Z-2050-DS	300-330	50	1236 (5)
Z-20100-D	300-330	100	1950 (4)
Z-20100-DS	300-330	100	1886 (5)
Z-20150-D	300-330	150	2500 (4)
Z-20150-DS	300-330	150	2436 (5)
Z-20200-D	300-330	200	3100 (4)
Z-20200-DS	300-330	200	3036 (5)

(3)  
 Senza deceleratori  
 Without shock-absorbers  
 Ohne Stoßdämpfer  
 Sans amortisseurs de chocs  
 Sin amortiguadores  
 Sem amortecedores

(4)  
 Con deceleratori  
 With shock-absorbers  
 Mit Stoßdämpfer  
 Avec amortisseurs de chocs  
 Con amortiguadores  
 Sem amortecedores

(5)  
 Solo su richiesta, senza deceleratori, ma predisposta  
 Only on request, without shock-absorbers, but with prearrangement  
 Nur auf Anfrage, ohne Stoßdämpfer, für Stoßdämpfer vorbereitet  
 Seulement en option, sans décélérateurs, mais prédisposée  
 Sólo bajo pedido, sin amortiguadores, pero preparada para su instalación  
 Apenas mediante solicitação, sem amortecedores, mas predisposta

**Slitte**  
**Slides**  
**Schlitten**  
**Tables de translation**  
**Correderas**  
**Corrediças**



Pinza integrada con slitta  
 Grippers integrated with slide  
 Integrierte Schlitten-Greif-Einheit  
 Pinces combinées avec translation  
 Pinza integrada con corredera  
 Pinças combinadas com corrediça

ZX	F	s	m [g]
<b>PZX-265</b>	110-130 N	2x4 mm	640
	93-105 N	50 mm	
<b>AZX-265</b>	50-56 Ncm	2x34°	615
	93-105 N	50 mm	
<b>RZX-265</b>	180-200 Ncm	2x92°	625
	93-105 N	50 mm	



Mini-slitta  
 Mini-slides  
 Mini-Schlitten  
 Mini-glissières  
 Minicorredera  
 Mini-corrediças

ZE-P	F [N]	s [mm]	m [g]
<b>ZE0610P</b>	10-13	10	90
<b>ZE0620P</b>	10-13	20	105
<b>ZE0630P</b>	10-13	30	120
<b>ZE1010P</b>	33-40	10	150
<b>ZE1020P</b>	33-40	20	175
<b>ZE1030P</b>	33-40	30	200
<b>ZE1610P</b>	100-110	10	265
<b>ZE1620P</b>	100-110	20	295
<b>ZE1630P</b>	100-110	30	340



Slitte a ricircolo di sfere  
 Slides recirculating ball-bearings  
 Schlitten mit Kugelumlaufrührung  
 Tables de translation, guidage à billes  
 Corredera de recirculación de bolas  
 Corrediça de rolamentos de esferas recirculantes

ZV	F [N]	s [mm]	m [g]
<b>ZV25030DS</b> <span style="background-color: red; color: white; padding: 2px;">NEW</span>	238-265	30	610
<b>ZV25030DSKP</b> <span style="background-color: red; color: white; padding: 2px;">NEW</span>	238-265	30	660
<b>ZV25060DS</b> <span style="background-color: red; color: white; padding: 2px;">NEW</span>	238-265	60	730
<b>ZV25060DSKP</b> <span style="background-color: red; color: white; padding: 2px;">NEW</span>	238-265	60	780
<b>ZV25100DS</b> <span style="background-color: red; color: white; padding: 2px;">NEW</span>	238-265	100	1000
<b>ZV25100DSKP</b> <span style="background-color: red; color: white; padding: 2px;">NEW</span>	238-265	100	1050
<b>ZV25150DS</b> <span style="background-color: red; color: white; padding: 2px;">NEW</span>	238-265	150	1320
<b>ZV25150DSKP</b> <span style="background-color: red; color: white; padding: 2px;">NEW</span>	238-265	150	1370
<b>ZV25200DS</b> <span style="background-color: red; color: white; padding: 2px;">NEW</span>	238-265	200	1635
<b>ZV25200DSKP</b> <span style="background-color: red; color: white; padding: 2px;">NEW</span>	238-265	200	1685



Slitte a ricircolo di sfere  
 Slides recirculating ball-bearings  
 Schlitten mit Kugelumlaufrührung  
 Tables de translation, guidage à billes  
 Corredera de recirculación de bolas  
 Corrediça de rolamentos de esferas recirculantes

ZA	F [N]	s [mm]	m [g]
<b>ZA0610</b>	22-29	10	100
<b>ZA0620</b>	22-29	20	120
<b>ZA0630</b>	22-29	30	135
<b>ZA0640</b>	22-29	40	170
<b>ZA0650</b>	22-29	50	205
<b>ZA0810</b>	38-51	10	170
<b>ZA0820</b>	38-51	20	185
<b>ZA0830</b>	38-51	30	215
<b>ZA0840</b>	38-51	40	270
<b>ZA0850</b>	38-51	50	310
<b>ZA0875</b>	38-51	75	450
<b>ZA1210</b>	101-122	10	390
<b>ZA1220</b>	101-122	20	390
<b>ZA1230</b>	101-122	30	395
<b>ZA1240</b>	101-122	40	440
<b>ZA1250</b>	101-122	50	535
<b>ZA1275</b>	101-122	75	715
<b>ZA12100</b>	101-122	100	955
<b>ZA1610</b>	196-217	10	645
<b>ZA1620</b>	196-217	20	645
<b>ZA1630</b>	196-217	30	650
<b>ZA1640</b>	196-217	40	710
<b>ZA1650</b>	196-217	50	820
<b>ZA1675</b>	196-217	75	1150
<b>ZA16100</b>	196-217	100	1475
<b>ZA16125</b>	196-217	125	1800
<b>ZA2010</b>	309-339	10	1100
<b>ZA2020</b>	309-339	20	1110
<b>ZA2030</b>	309-339	30	1110
<b>ZA2040</b>	309-339	40	1210
<b>ZA2050</b>	309-339	50	1360
<b>ZA2075</b>	309-339	75	1745
<b>ZA20100</b>	309-339	100	2320
<b>ZA20125</b>	309-339	125	2845
<b>ZA20150</b>	309-339	150	3370

Attuatori lineari  
 Linear actuators  
 Lineareinheiten  
 Vérins linéaires  
 Actuadores lineales  
 Actuadores lineares



*gimapick*

M25	F [N]	s [mm]	m [g]
M2550	222-265	50	2800
M2550E	222-265	50	2750
M25100	222-265	100	3400
M25100E	222-265	100	3350
M25160	222-265	160	3900
M25160E	222-265	160	3850
M25200	222-265	200	4700
M25200E	222-265	200	4640
M25300	222-265	300	5600
M25300E	222-265	300	5530
M25400	222-265	400	6400
M25400E	222-265	400	6250



*gimapick*

P25	F [N]	s [mm]	m [g]
P2550	222-265	50	3300
P2550E	222-265	50	3250
P25100	222-265	100	3900
P25100E	222-265	100	3850



*gimapick*

D32	F [N]	s [mm]	m [g]
D3250	400	50	2300
D32100	400	100	3300

Unità di traslazione lineare  
 Pneumatic linear slide  
 Pneumatische Lineareinheit  
 Unité linéaire pneumatique  
 Unidad de traslación lineal  
 Unidade linear pneumática



L40	F [N]	s [mm]	m [g]
L40-0300	350	300	10400
L40-0500	350	500	13200
L40-0800	350	800	17000
L40-1000	350	1000	19800
L40-1500	350	1500	26600
L40-2000	350	2000	33400



*gimapick*  
 Design Award Winner 1999

Gimapick è un sistema modulare di Pick&Place ad elevata componibilità che consente di realizzare facilmente manipolatori cartesiani con tre assi lineari, attuatori rotanti ed estremità di presa.

Gimapick is modular Pick&Place system, very easy to assembly allowing to build up three linear axes Cartesian manipulators with Rotary actuators and gripping units.







Gimapick ist ein Baukastensystem für Pick&Place, das sehr einfach zusammengesetzt werden kann. Es erlaubt, 3-Achssysteme mit Drehantrieb und Greiffingern zusammenzubauen, Luftdurchführungen sind integriert.



Gimapick est un système modulaire de Pick&Place à assemblage aisé, pour construire des manipulateurs cartésien avec trois axes linéaires, unités rotatives et pinces de préhension.

Gimapick es un sistema modular de Pick&Place de elevada componibilidad que permite realizar fácilmente manipuladores cartesianos con tres ejes lineales, actuadores rotatorios y pinzas de toma.

Gimapick é um sistema modular de Pick&Place de fácil montagem, que permite realizar facilmente manipuladores cartesianos com três eixos lineares, atuadores rotativos e unidades de prensão.

**Interfacce**  
**Interfaces**  
**Schnittstellen**  
**Interfaces**  
**Interfaces**  
**Interfaces**

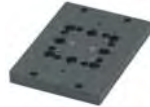
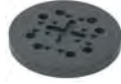
	m [g]
<b>A25</b>	540
	m [g]
<b>A26</b>	500
	m [g]
<b>A27</b>	750
	m [g]
<b>A28</b>	600
	m [g]
<b>C31</b>	360
	m [g]
<b>C32</b>	440
	m [g]
<b>i25</b>	120

	m [g]
<b>i26</b>	350
	m [g]
<b>i27</b>	150
	m [g]
<b>i28</b>	400
	m [g]
<b>i29</b>	340

**Connessioni**  
**Connections**  
**Verbindungen**  
**Connections**  
**Conexiones**  
**Conexões**

	m [g]
<b>M2550-9</b>	2
<b>M2550-26</b>	3
<b>PMA-TEA-BFIO-P112T</b>	8
<b>TEAFLEX-PKN11M6x2.5</b>	10
<b>PMA-TEA-BVND-P112</b>	6
<b>PMA-TEA-BVWD-P112</b>	10
<b>TEAFLEX-D22</b>	5
<b>PMA-TEA-PIST-12B</b>	32
<b>H25</b>	100



**Guide lineari a ricircolo di sfere**  
**Linear guidance with recirculating ball-bearing**  
**Kugelumlaufführung**  
**Guide linéaire avec nouvelle circulation des billes**  
**Guías lineales de circulación de bolas**  
**Guia linear com circulação de esferas**

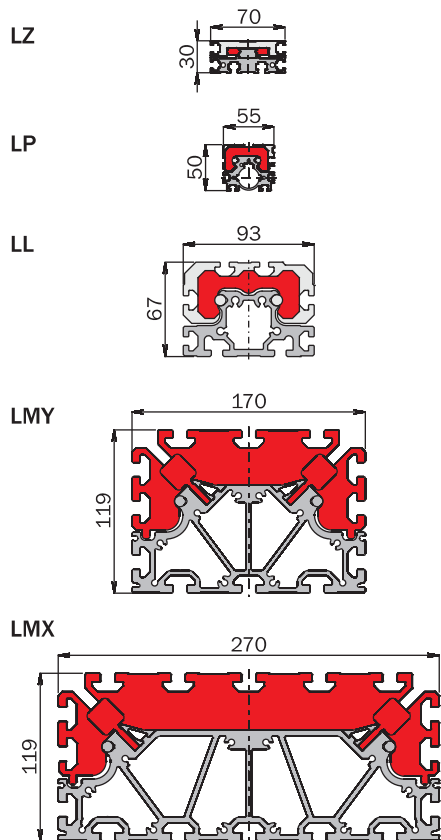

**Guide lineari serie LZ**  
**Linear guides (series LZ)**  
**Linearfürungen (Baureihe LZ)**  
**Guides linéaires (série LZ)**  
**Guías lineales (serie LZ)**  
**Guias lineares (série LZ)**



Per cilindri ISO 6432 Ø12, Ø16  
 For ISO 6432 cylinders Ø12, Ø16  
 Für Zylinder ISO 6432 Ø12, Ø16  
 Pour cylindres ISO 6432 Ø12, Ø16  
 Para cilindros ISO 6432 Ø12, Ø16  
 Para cilindros ISO 6432 Ø12, Ø16

	s [mm]	m [g]
<b>LZ00-0050</b>	50	645
<b>LZ00-0100</b>	100	750
<b>LZ00-0160</b>	160	875
<b>LZ00-0200</b>	200	965



Per cilindri senza stelo Origa OSP-P10, OSP-P16  
 For Origa OSP-P10, OSP-P16 rodless cylinders  
 Für Origa Zylinder OSP-P10, OPS-P16 ohne Kolbenstange  
 Pour cylindres sans tige Origa OSP-P10, OSP-P16  
 Para cilindros sin vástago Origa OSP-P10, OSP-P16  
 Para cilindros sem haste Origa OSP-P10, OSP-P16

	s [mm]	m [g]
<b>LZ01-0200</b>	200	1070
<b>LZ01-0300</b>	300	1290
<b>LZ01-0400</b>	400	1500



**Guide lineari serie LP**  
**Linear guides (series LP)**  
**Linearfürungen (Baureihe LP)**  
**Guides linéaires (série LP)**  
**Guías lineales (serie LP)**  
**Guias lineares (série LP)**



Per cilindri ISO 6432 Ø12, Ø16 - For ISO 6432 cylinders Ø12, Ø16  
 Für Zylinder ISO 6432 Ø12, Ø16 - Pour cylindres ISO 6432 Ø12, Ø16  
 Para cilindros ISO 6432 Ø12, Ø16 - Para cilindros ISO 6432 Ø12, Ø16

	s [mm]	m
<b>LP00</b>	0+1500 (9)	575g + 2.28g/mm



Per cilindro senza stelo Origa OSP-P16 - For Origa OSP-P16 rodless cylinder  
 Für Origa Zylinder OPS-P16 ohne Kolbenstange - Pour cylindre sans tige Origa OSP-P16  
 Para cilindros sin vástago Origa OSP-P16 - Para cilindros sem haste Origa OSP-P16

	s [mm]	m
<b>LP01</b>	0+1500 (9)	640g + 2.28g/mm



Per motori lineari LinMot P01-23 - For linear motor LinMot P01-23  
 Für Linearmotoren LinMot P01-23 - Pour moteurs linéaires LinMot P01-23  
 Para motores lineales LinMot P01-23 - Para motores lineares LinMot P01-23

	s [mm]	m [g]
<b>LP02-0050</b>	50	800
<b>LP02-0100</b>	100	1000



Per cilindro senza stelo Festo DGP-18 e per motorlineari LinMot  
 For Festo DGP-18 rodless cylinder and for linear motor LinMot  
 Für Festo Zylinder DGP-18 ohne Kolbenstange und LinMot Linearmotoren  
 Pour cylindre sans tige Festo DGP-18 et pour moteurs linéaires LinMot  
 Para cilindro sin vástago Festo DGP-18 y para motores lineales LinMot  
 Para cilindros sem haste Festo DGP-18 e para motores lineares LinMot

	s [mm]	m
<b>LP03</b>	0+1500 (9)	685g + 2.28g/mm

i  
 Interasse carrelli - Carrier interaxis  
 Achsabstand Laufwagen - Entre-axes chariots  
 Distancia entre eje de los carros - Entre eixo carreiras

(9)  
 E' possibile ordinare qualsiasi lunghezza di guida con step di 1mm  
 It is possible to order any guidance length in 1mm steps  
 Es ist möglich, jede Führungslänge mit jeweils 1mm Längeunterschied zu bestellen  
 Il est possible de commander n'importe quelle longueur de glissière avec step de 1mm  
 Se puede solicitar cualquier longitud de guía con pasos de 1 mm  
 É possível encomendar qualquer comprimento de corredeira com passos de 1mm



Trasmissione a omega, completa di calettatore per alberi Ø10  
 Omega transmission, with Ø10 shaft locking assembly  
 Omegaantrieb vollständig mit Spannsatz für Wellen Ø10  
 Transmission à omega, complète de élément de serrage pour arbres Ø10  
 Transmisión de omega, dotada con elemento de bloqueo para ejes de Ø10  
 Transmissão de ómega, com montagem de bloqueio de mandril Ø10

	s [mm]	m
<b>LP06</b>	0+1500 (10)	1300g + 2.3g/mm



Trasmissione a cinghia e pulegge, completa di calettatore per alberi Ø10  
 Belt drive and pulleys, with Ø10 shaft locking assembly  
 Riemenantrieb und Riemenscheiben, vollständig mit Spannsatz für Wellen Ø10  
 Transmission par courroie et poulies, complète de élément de serrage pour arbres Ø10  
 Transmisión por correa y poleas, dotada con elemento de bloqueo para ejes de Ø10  
 Transmissão por correia e roldanas, com montagem de bloqueio de mandril Ø10

	s [mm]	m
<b>LP07</b>	0+1500 (10)	1470g + 2.33g/mm



Con due carrelli autocentranti - With two self-centering carriers  
 Mit zwei selbstzentrierenden Laufwagen - Avec deux chariots autocentrants  
 Con dos carros autocentrantes - Com duas carreiras auto-centrantes

	i [mm]	m
<b>LP08</b>	96+1500 (9)	940g + 2.34g/mm



Con cilindro senza stelo Ø25 a trascinamento magnetico  
 With rodless cylinder Ø25 magnetically coupled  
 Mit magnetisch gekoppeltem Zylinder ohne Kolbenstange Ø25  
 Avec cylindre sans tige Ø25 à traction magnétique  
 Con cilindro sin vástago Ø25 de arrastre magnético  
 Com cilindros sem haste Ø25 com tracção magnética

	s [mm]	m [g]
<b>LP10-0300</b>	300	1970
<b>LP10-0500</b>	500	2500
<b>LP10-1000</b>	1000	3860
<b>LP10-1500</b>	1500	5200

(10)  
 E' possibile ordinare qualsiasi lunghezza di guida con step di 100mm  
 It is possible to order any guidance length in 100mm steps  
 Es ist möglich, jede Führungslänge mit jeweils 100mm Längeunterschied zu bestellen  
 Il est possible de commander n'importe quelle longueur de glissière avec step de 100mm  
 Se puede solicitar cualquier longitud de guía con pasos de 100 mm  
 É possível encomendar qualquer comprimento de corredeira com passos de 100mm

**Guide lineari serie LL**  
**Linear guides (series LL)**  
**Linearfürungen (Baureihe LL)**  
**Guides linéaires (série LL)**  
**Guías lineales (serie LL)**  
**Guias lineares (série LL)**



Per cilindri ISO 6432 Ø20, Ø25, Ø32  
 For ISO 6432 cylinders Ø20, Ø25, Ø32  
 Für Zylinder ISO 6432 Ø20, Ø25, Ø32  
 Pour cylindres ISO 6432 Ø20, Ø25, Ø32  
 Para cilindros ISO 6432 Ø20, Ø25, Ø32  
 Para cilindros ISO 6432 Ø20, Ø25, Ø32

	s [mm]	m
<b>LL00</b>	0+5830 (9)	1560g + 4.2g/mm
<b>LL00-0100</b>	100	2020g
<b>LL00-0160</b>	160	2260g
<b>LL00-0200</b>	200	2440g
<b>LL00-0250</b>	250	2650g
<b>LL00-0350</b>	350	3060g
<b>LL00-0400</b>	400	3290g
<b>LL00-0500</b>	500	3710g



Per cilindri senza stelo Ø25  
 For rodless cylinders Ø25  
 Für Zylinder ohne Kolbenstange Ø25  
 Pour cylindres sans tige Ø25  
 Para cilindros sin vástago Ø25  
 Para cilindros sem haste Ø25

	s [mm]	m
<b>LL01</b>	0+5740 (9)	1980g + 4.2g/mm
<b>LL01-0300</b>	300	3240g
<b>LL01-0400</b>	400	3660g
<b>LL01-0500</b>	500	4090g
<b>LL01-0800</b>	800	5360g
<b>LL01-1000</b>	1000	6200g



Trasmissione a omega, completa di calettatore per alberi Ø12  
 Omega transmission, with Ø12 shaft locking assembly  
 Omega-Antrieb vollständig mit Spannsatz für Wellen Ø12  
 Transmission à omega, complète de élément de serrage pour arbres Ø12  
 Transmisión de omega, dotada con elemento de bloqueo para ejes de Ø12  
 Transmissão Omega, com montagem de bloqueio de mandril de Ø12

	s [mm]	m
<b>LL06</b>	0+5700 (10)	3220g + 4.3g/mm

i  
 Interasse carrelli - Carrier interaxis  
 Achsabstand Laufwagen - Entre-axes chariots  
 Distancia entre eje de los carros - Entre eixo carreiras



Trasmissione a cinghia e pulegge, completa di calettatore per alberi Ø12  
 Belt drive and pulleys, with Ø12 shaft locking assembly  
 Riemenantrieb und Riemenscheiben, vollständig mit Spannsatz für Wellen Ø12  
 Transmission par courroie et poulies, complète de élément de serrage pour arbres Ø12  
 Transmisión por correa y poleas, dotada con elemento de bloqueo para ejes de Ø12  
 Correia e roldanas, com montagem de bloqueio de mandril de Ø12.

	s [mm]	m
<b>LL07</b>	0+1500 (10)	3660g + 4.4g/mm



Con due carrelli autocentranti  
 With two self-centering carriers  
 Mit zwei selbstzentrierenden Laufwagen  
 Avec deux chariots autocentrants  
 Con dos carros autocentrantes  
 Com duas carreiras auto-centrantes

	i [mm]	m
<b>LL08</b>	140+2000 (9)	3000g + 4.3g/mm



Per cilindro senza stelo Ø25 a trascinamento magnetico  
 For rodless cylinder Ø25 magnetically coupled  
 Für magnetisch gekoppeltem Zylinder ohne Kolbenstange Ø25  
 Pour cylindre sans tige Ø25 à traction magnétique  
 Para cilindro sin vástago Ø25 de arrastre magnético  
 Para cilindros sem haste Ø25 acoplado magneticamente

	s [mm]	m
<b>LL10-0300</b>	300	3600g
<b>LL10-0500</b>	500	4550g
<b>LL10-1000</b>	1000	6900g
<b>LL10-1500</b>	1500	9250g

(9)  
 E' possibile ordinare qualsiasi lunghezza di guida con step di 1mm  
 It is possible to order any guidance length in 1mm steps  
 Es ist möglich, jede Führungslänge mit jeweils 1mm Längeunterschied zu bestellen  
 Il est possible de commander n'importe quelle longueur de glissière avec step de 1mm  
 Se puede solicitar cualquier longitud de guía con pasos de 1 mm  
 É possível encomendar qualquer comprimento de correção com passos de 1mm

(10)  
 E' possibile ordinare qualsiasi lunghezza di guida con step di 100mm  
 It is possible to order any guidance length in 100mm steps  
 Es ist möglich, jede Führungslänge mit jeweils 100mm Längeunterschied zu bestellen  
 Il est possible de commander n'importe quelle longueur de glissière avec step de 100mm  
 Se puede solicitar cualquier longitud de guía con pasos de 100 mm  
 É possível encomendar qualquer comprimento de correção com passos de 100mm

**Guide lineari serie LMX / LMY**  
**Linear guides (series LMX / LMY)**  
**Linearfürungen (Baureihe LMX / LMY)**  
**Guides linéaires (série LMX / LMY)**  
**Guías lineales (serie LMX / LMY)**  
**Guias lineares (série LMX / LMY)**



Per cilindri ISO 6431 Ø40 e Ø50 e per cilindro senza stelo Ø32  
 For ISO 6431 cylinders Ø40 and Ø50 and for rodless cylinders Ø32  
 Für Zylinder ISO 6431 Ø40 und Ø50 und für Zylinder ohne Kolbenstange Ø32  
 Pour cylindres ISO 6431 Ø40 et Ø50 et pour cylindres sans tige Ø32  
 Para cilindros ISO 6431 Ø40 y Ø50 y para cilindros sin vástago Ø32  
 Para cilindros ISO 6431 Ø40 e Ø50 e para cilindros sem haste Ø32

	s [mm]	m
<b>LMY01</b>	0+5700 (9)	6100g + 11.06g/mm
<b>LMX01</b>	0+5600 (9)	11800g + 16.4g/mm



Con cilindro pneumatico e trasmissione a cinghia  
 With pneumatic cylinder and belt drive  
 Mit pneumatischem Zylinder und Riemenantrieb  
 Avec cylindres pneumatique et transmission par courroie  
 Con cilindro neumático y transmisión por correa  
 Com cilindro pneumático e correa de transmissão

	s [mm]	m [g]
<b>LMY03-0300</b>	300	11350
<b>LMY03-0500</b>	500	14000
<b>LMY03-0800</b>	800	18000
<b>LMY03-1000</b>	1000	20600
<b>LMY03-1500</b>	1500	27200
<b>LMY03-2000</b>	2000	33800
<b>LMX03-0300</b>	300	18150
<b>LMX03-0500</b>	500	21850
<b>LMX03-0800</b>	800	27450
<b>LMX03-1000</b>	1000	31150
<b>LMX03-1500</b>	1500	40400
<b>LMX03-2000</b>	2000	49700



Trasmissione a omega, completa di calettatore per alberi Ø16  
 Omega transmission, with Ø16 shaft locking assembly  
 Omegaantrieb, vollständig mit Spannsatz für Wellen Ø16  
 Transmission à omega, complète de élément de serrage pour arbres Ø16  
 Transmisión de omega, dotada con elemento de bloqueo para ejes Ø16  
 Transmissão Omega com montagem de bloqueio de eixo de Ø16

	s [mm]	m
<b>LMY06</b>	0+5700 (10)	9000g + 11.15g/mm
<b>LMX06</b>	0+5600 (10)	14700g + 16.5g/mm

(9)

E' possibile ordinare qualsiasi lunghezza di guida con step di 1mm  
 It is possible to order any guidance length in 1mm steps  
 Es ist möglich, jede Führungslänge mit jeweils 1mm Längeunterschied zu bestellen  
 Il est possible de commander n'importe quelle longueur de glissière avec step de 1mm  
 Se puede solicitar cualquier longitud de guía con pasos de 1 mm  
 É possível encomendar qualquer comprimento de corredeira com passos de 1mm



Con trasmissione destra a cinghia e pulegge, completa di calettatore per alberi Ø16  
 With right belt drive and pulleys, with Ø16 shaft locking assembly  
 Mit rechtem Riemenantrieb und Riemenscheiben, vollständig mit Spannsatz für Wellen Ø16  
 Avec transmission droite par courroie et puoiles, complète de élément de serrage pour arbres Ø16  
 Con transmisión derecha por correa y poleas, dotada con elemento de bloqueo para ejes Ø16  
 Correia de transmissão direita e roldanas, com montagem de bloqueio de eixo de Ø16

	s [mm]	m
<b>LMY07D</b>	0+2700 (10)	9400g + 13g/mm
<b>LMX07D</b>	0+2600 (10)	15100g + 18.2g/mm



Con trasmissione sinistra a cinghia e pulegge, completa di calettatore per alberi Ø16  
 With left belt drive and pulleys, with Ø16 shaft locking assembly  
 Mit linkem Riemenantrieb und Riemenscheiben, vollständig mit Spannsatz für Wellen Ø16  
 Avec transmission gauche par courroie et puoiles, complète de élément de serrage pour arbres Ø16  
 Con transmisión izquierda por correa y poleas, dotada con elemento de bloqueo para ejes Ø16  
 Correia de transmissão esquerda e roldanas, com montagem de bloqueio de eixo de Ø16

	s [mm]	m
<b>LMY07S</b>	0+2700 (10)	9400g + 13g/mm
<b>LMX07S</b>	0+2600 (10)	15100g + 18.2g/mm

(10)

E' possibile ordinare qualsiasi lunghezza di guida con step di 100mm  
 It is possible to order any guidance length in 100mm steps  
 Es ist möglich, jede Führungslänge mit jeweils 100mm Längeunterschied zu bestellen  
 Il est possible de commander n'importe quelle longueur de glissière avec step de 100mm  
 Se puede solicitar cualquier longitud de guía con pasos de 100 mm  
 É possível encomendar qualquer comprimento de corredeira com passos de 100mm

**Attuatori rotanti**  
**Swivelling units**  
**Schwenkeinheiten**  
**Unités rotatives**  
**Actuadores rotatorios**  
**Actuadores rotativos**



*gimapick*

R	C [Ncm]	s	m [g]
R20	113	180°	400
R32	434	180°	1000
R63	2244	180°	3400
R21	113	180°/90°	500
R33	434	180°/90°	1200
R64	2244	180°/90°	3200



RT	C [Ncm]	s	m [g]
RT-10	28	190°	235
RT-12	56	190°	560
RT-20	198	190°	965
RT-25	397	190°	1680
RT-35	779	190°	2475
RT-45	1669	190°	5250
RT-63	3926	190°	8185



Unità di arresto intermedio - Intermediate stopping unit  
 Zwischenanschlagseinheit - Unités pour arrêt intermédiaire  
 Unidad de parada intermedia - Unidade para paragem intermédia

RTD	m [g]
RTD-10	55
RTD-12	100
RTD-20	190
RTD-25	300
RTD-35	450
RTD-45	1000
RTD-63	1675

**Tavole rotanti**  
**Rotary indexing tables**  
**Rundschalteinheiten**  
**Tables rotatives**  
**Mesas rotatorias**  
**Mesas de indexação rotativas**



ITSC	C [Ncm]	s	m [g]
ITSC-164	136	4x90°	320
ITSC-164A	136	4x90°	320
ITSC-166	167	6x60°	320
ITSC-166A	167	6x60°	320
ITSC-168	181	8x45°	320
ITSC-168A	181	8x45°	320
ITSC-454	2290	4x90°	3740
ITSC-454A	2290	4x90°	3740
ITSC-456	2644	6x60°	3740
ITSC-456A	2644	6x60°	3740
ITSC-458	2821	8x45°	3960
ITSC-458A	2821	8x45°	3960



Blocco porta deceleratore (con deceleratore idraulico)  
 Shock-absorber holder block (with shock-absorber)  
 Stoßdämpfer-Halterblock (mit Stoßdämpfer)  
 Bloc de support d'amortisseur (avec amortisseur hydraulique)  
 Bloque portaamortiguador (con amortiguador hidráulico)  
 Bloco de suporte de amortecedor (com amortecedor hidráulico)

ITSC-45-DE	m [g]
ITSC-45-DE	290



Sottogruppo corona  
 Profile cam  
 Nockenkranz  
 Couronne a came  
 Subgrupo corona  
 Coroa de came

	m [g]
ITSC-45-S4	90
ITSC-45-S6	105
ITSC-45-S8	120

Tavole rotanti  
 Rotary indexing tables  
 Rundschalteinheiten  
 Tables rotatives  
 Mesas rotatorias  
 Mesas de indexação rotativas



TRB		C [Ncm]	s	m [g]
TRB05003C	NEW	700	3x120°	13000 (11)
TRB05003A	NEW	700	3x120°	13000 (11)
TRB05004C	NEW	700	4x90°	13000 (11)
TRB05004A	NEW	700	4x90°	13000 (11)
TRB05006C	NEW	700	6x60°	13000 (11)
TRB05006A	NEW	700	6x60°	13000 (11)
TRB05008C	NEW	700	8x45°	13000 (11)
TRB05008A	NEW	700	8x45°	13000 (11)
TRB05012C	NEW	700	12x30°	13000 (11)
TRB05012A	NEW	700	12x30°	13000 (11)

(11)  
 Nel prezzo sono inclusi due deceleratori  
 The price includes two shock-absorbers  
 Preis einschließlich zwei Stoßdämpfer  
 Le prix comprend les deux amortisseurs de chocs  
 En el precio se incluyen dos amortiguadores  
 O preço inclui dois amortecedores

Sensori magnetici per cave a "T"  
 Magnetic sensors for "T" slot  
 Magnetische sensoren für "T" nuten  
 Capteur magnétique pour rainures à "T"  
 Sensores magnéticos para ranuras en forma de "T"  
 Sensor magnético para ranhuras em "T"

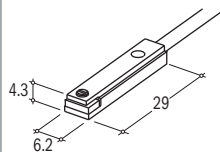

SL-G			m [g]
SL3N203-G	PNP	M8 connector	5
SL4N225-G	PNP	2.5m cable	23
SL3M203-G	NPN	M8 connector	5
SL4M225-G	NPN	2.5m cable	23

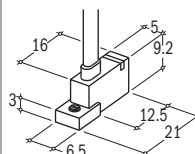

SC-Y			m [g]
SC3N203Y	PNP	M8 connector	5
SC4N225Y	PNP	2.5m cable	23

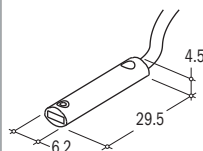

SA-G			m [g]
SA3N203-G	PNP	M8 connector	4
SA4N225-G	PNP	2.5m cable	22
SA3M203-G	NPN	M8 connector	4
SA4M225-G	NPN	2.5m cable	22

Sensori magnetici per cave a coda di rondine  
 Magnetic sensors for dovetail slot  
 Magnetische sensoren für schwalbenschwanznuten  
 Capteur magnétique pour rainures à queue d'hirondelle  
 Sensores magnéticos para ranuras en forma de cola de milano  
 Sensor magnético para ranhuras em cauda de andorinha

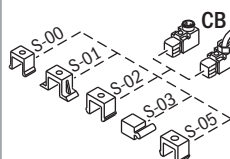

CB-G			m [g]
CB4N225-G	PNP	2.5m cable	63
CB3N2-G	PNP	M8 connector	13
CB4M225-G	NPN	2.5m cable	63
CB3M2-G	NPN	M8 connector	13

**Sensori magnetici per cilindri con tirante**  
**Magnetic sensors for tie-rod cylinders**  
**Magnetische sensoren für zuganker zylinder**  
**Capteur magnétique pour cylindres eu tirants**  
**Sensores magnéticos para cilindro con tirante**  
**Sensores magnéticos para cilindro com tirante**

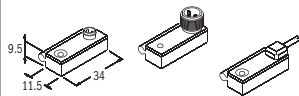

<b>SM-G</b>			m [g]
<b>SM4N225-G</b>	PNP	2.5m cable	55
<b>SM3N2-G</b>	PNP	M8 connector	5
<b>SM6N2-G</b>	PNP	M12 connector	6
<b>SM4M225-G</b>	NPN	2.5m cable	55
<b>SM3M2-G</b>	NPN	M8 connector	5
<b>SM6M2-G</b>	NPN	M12 connector	6

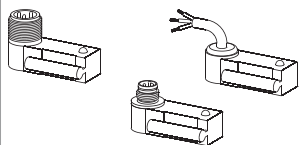

<b>SM-G-IP68</b>			m [g]
<b>SM7N225-G</b>	NPN	2.5m cable	22
<b>SM8N2-G</b>	NPN	M8 connector	4
<b>SM9N2-G</b>	NPN	M12 connector	4

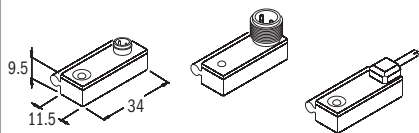

<b>SM-G-NC</b>			m [g]
<b>SM4P225-G</b>	PNP	2.5m cable	55
<b>SM3P2-G</b>	PNP	M8 connector	5
<b>SM4L225-G</b>	NPN	2.5m cable	55
<b>SM3L2-G</b>	NPN	M8 connector	5

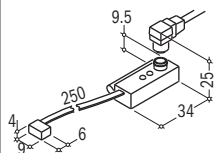

<b>SMR-G</b>			m [g]
<b>SM4NR225-G</b>	PNP	2.5m cable	56
<b>SM3NR2-G</b>	PNP	M8 connector	6
<b>SM4MR225-G</b>	NPN	2.5m cable	56
<b>SM3MR2-G</b>	NPN	M8 connector	6

**Sensori magnetici per cave a "C"**  
**Magnetic sensors for "C" slot**  
**Magnetische sensoren für "C" nuten**  
**Capteur magnétique pour rainures à "C"**  
**Sensores magnéticos para ranuras en forma de "C"**  
**Sensor magnético para ranhuras em "C"**

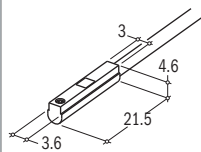

<b>SS-G</b>			m [g]
<b>SS3N203-G</b>	PNP	M8 connector	4
<b>SS4N225-G</b>	PNP	2.5m cable	22
<b>SS3M203-G</b>	NPN	M8 connector	4
<b>SS4M225-G</b>	NPN	2.5m cable	22

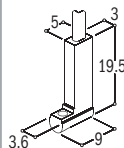

<b>SN-G</b>			m [g]
<b>SN3N203-G</b>	PNP	M8 connector	4
<b>SN4N225-G</b>	PNP	2.5m cable	22
<b>SN3M203-G</b>	NPN	M8 connector	4
<b>SN4M225-G</b>	NPN	2.5m cable	22

**Sensori induttivi**  
**Inductive sensors**  
**Induktive Sensoren**  
**Capteurs inductifs**  
**Sensores inductivos**  
**Sensores indutivos**



<b>SI</b>			m [g]
<b>SI4M225-G</b>	NPN	2.5m cable	20
<b>SI4N225-G</b>	PNP	2.5m cable	20

**Sensori d'urto**  
**Shock sensors**  
**Schocksensoren**  
**Détecteur de choc**  
**Sensores de golpes**  
**Detetor de choque**



SG	m [g]
<b>SG3A2-G</b>	17
<b>SG3N2-G</b>	17
<b>SG3M2-G</b>	17

**Tester multi-sensore**  
**Multi-sensor tester**  
**Prüfgerät multi-sensor**  
**Testeur multi détecteurs**  
**Têster multisensor**  
**Testador multi detetores**



SB2T	m [g]
	1400

**Accessori per sensori magnetici**  
**Magnetic sensors accessories**  
**Zubehör magnetische sensoren**  
**Accessoires pour capteur magnétique**  
**Accesorios para sensores magnéticos**  
**Acessórios para sensor magnético**

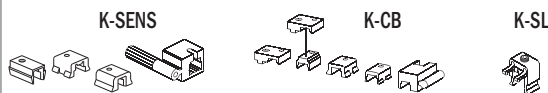

Adattatori per cave  
Slot adapters  
Passstücke für nuten  
Adaptateurs pour rainures  
Adaptadores para ranuras  
Adaptadores para ranhuras

K	m [g]
<b>K-SENS</b>	1
<b>K-CB</b>	8
<b>K-SL</b>	5

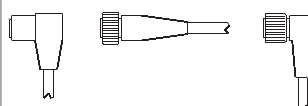

SNAP M8 M12  
Connettore  
Connector  
Steckverbinder  
Connecteurs  
Conector  
Conectores

CF		m [g]
<b>CFSM890225</b>	SNAP	50
<b>CFSM890325</b>	SNAP	50
<b>CFGM800225</b>	M8	53
<b>CFGM800325</b>	M8	53
<b>CFGM1290225</b>	M12	57
<b>CFGM1290325</b>	M12	57

F [N]	Forza	Force	Kraft	Force	Fuerza	Força
C [Ncm]	Coppia	Torque	Drehmoment	Couple	Par	Binário
s [mm]	Corsa	Stroke	Hub	Course	Carrera	Curso
m [g]	Peso	Weight	Gewicht	Poids	Peso	Peso

Tutte le forze e le coppie sono riferite ad una pressione di 6 bar.  
Le forze, o le coppie, delle pinze sono totali.

All forces and torques are related to a pressure of 6 bar.  
The forces, or the torques, of the grippers are total values.

Alle Kräfte und Drehmomente beziehen sich auf einen Druck von 6 bar.  
Die Kräfte oder die Drehmomente der Greifer sind Gesamtwerte.

Les données relatives à la force et au couple sont rapportées à la pression de 6 bars.  
Les forces, ou les couples, des pinces de préhension sont totales.

Todas las fuerzas y los pares se refieren a una presión de 6 bar.  
Las fuerzas, o los pares de las pinzas son totales.

Todas as forças e binários fazem referência à pressão de 6 bar.  
As forças, ou os binários, das pinças são valores totais.

Riservati tutti i diritti, traduzioni incluse. Proibita ogni forma di riproduzione o trasmissione senza permesso scritto ed approvato da GIMATIC SpA. Con riserva di modifiche ed aggiornamenti in qualsiasi momento e senza alcun preavviso.

All rights reserved, including translation rights. No parts of this publication may be reproduced or transmitted in any form or by any means, electronic, mechanical, photocopying or otherwise, without the prior written permission of GIMATIC SpA. We reserve the right to make alterations.

Alle Rechte, einschließlich Übersetzungen, vorbehalten. Jede Form von Vervielfältigung oder Übermittlung ohne eine schriftliche und von GIMATIC SpA genehmigte Bevollmächtigung ist untersagt. Unter Vorbehalt von jederzeit und ohne Vorankündigung antragbaren Änderungen und Erneuerungen.

Réservés tous droits, traductions incluses. Toutes formes de reproduction ou transmission par quelque procédé que ce soit, interdites sans autorisation écrite préalable par GIMATIC SpA. Avec réserve de modifications et de mise à jour sans préavis.

Todos los derechos reservados, incluyendo los derechos de traducción. Ninguna parte de esta publicación puede ser reproducida o transmitida en ninguna forma y por ningún medio, sea electrónico, mecánico, fotocopia u otro, sin permiso previo por escrito de Gimatic SpA. La empresa se reserva el derecho de aportar modificaciones sin previo aviso.

Todos os direitos reservados, inclusas traduções. É proibida qualquer forma de reprodução ou transmissão sem a autorização escrita e aprovada pela GIMATIC SpA. Reservamos o direito de efectuar modificações e actualizações em qualquer momento e sem aviso prévio.



Visitate il nostro sito ed avrete a disposizione tutti gli strumenti necessari con gli aggiornamenti, in tempo reale, sulle ultime novità di prodotto, i prezzi e la rete di vendita.

L'offerta Gimatic, oltre ai prodotti della sezione HANDLING mostrati in questa brochure, comprende una sezione PLASTICS dedicata ai componenti per l'asservimento di presse per stampaggio, una sezione SENSORS dedicata ai sensori per l'automazione ed una sezione MECHATRONICS dedicata agli attuatori elettrici.



Visit our website: you will have access to all the necessary tools with real-time updates on the latest news, prices and sales network.

In addition to the products of the HANDLING section shown in this brochure, the Gimatic offer includes a PLASTICS section dedicated to interlocking components for injection moulding machines and a SENSORS section dedicated to sensors for automation and a MECHATRONICS section dedicated to electric actuators.

## H A N D L I N G



Besuchen Sie unsere Website, dort finden Sie alle notwendigen technischen Informationen, die aktuellen Produktneuheiten, Preislisten und eine Übersicht zur Vertriebsstruktur.

Neben den in dieser Broschüre gezeigten Produkten der Rubrik HANDLING enthält das Angebot von Gimatic die Rubrik PLASTICS, die den Greifer- und sonstigen Komponenten für Spritzgusspressen gewidmet ist, die Rubrik SENSORS, die Sensoren für die Automation umfasst, und die Rubrik MECHATRONICS, die elektrische Antriebe beinhaltet.



Visitez notre site et vous aurez à disposition tous les instruments nécessaires avec toutes les mises à jour, en temps réel, sur les dernières nouveautés du produit, ainsi que la liste des prix et le réseau de vente.

L'offre Gimatic, en dehors des produits de la section HANDLING montrés dans cette brochure, comprend une section PLASTICS, dédiée aux composants pour l'asservissement de presses de moulage, une section SENSORS, dédiée aux capteurs pour l'automatisation, et une section MECHATRONICS, dédiée aux actionneurs électriques.

## P L A S T I C S



Visite nuestro sitio y tendrá a disposición todas las herramientas necesarias con todas las actualizaciones, en tiempo real, sobre las últimas novedades de los productos, los precios y la red de ventas.

La oferta Gimatic, además de los productos de la sección HANDLING indicados en este folleto, incluye una sección PLASTICS dedicada a los componentes para prensas de moldeo, una sección SENSORS dedicada a los sensores para la automatización y una sección MECHATRONICS dedicada a los actuadores eléctricos.



Visite o nosso site e terá ao seu dispor todos os instrumentos necessários de atualização, em tempo real, para as últimas novidades dos produtos, assim como a lista de preços e a rede de vendas.

A oferta Gimatic, para além dos produtos da secção HANDLING ilustrados no presente folheto, inclui uma secção PLASTICS, dedicada aos componentes para mecanismos de prensas para moldagens, uma secção SENSORS, dedicada aos sensores para a automatização e uma secção MECHATRONICS dedicada aos atuadores elétricos.

## S E N S O R S



## M E C H A T R O N I C S



CAT-SOM-HANDLING 09/2013



Gimatic S.p.A.

Via Enzo Ferrari, 2/4 - 25030 Roncadelle (BS) - ITALIA

Tel. +39 030 2584655 - Fax +39 030 2583886

www.gimatic.com - sales@gimatic.com